

# INSTRUCTION MANUAL

*W. D. Brown*  
*July 114*

**PLUG-IN**

**SPECTRUM**

**ANALYZERS**

**NR NELSON-ROSS ELECTRONICS INC.**

5-05 BURNS AVE., HICKSVILLE, N. Y.

---

MODELS:

PSA 001	PSA 011
PSA 002	PSA 012
PSA 003	PSA 013

THIS MANUAL IS ISSUED WITH

MODEL PSA NUMBER 011

SERIAL NUMBER 529

## TABLE OF CONTENTS

WARRANTY	Page
SECTION I CHARACTERISTICS	1-1
Scope	1-1
General Information	1-2
SECTION 2 OPERATING INSTRUCTIONS	2-1
Inspection and Installation	2-1
Initial Adjustments	2-1
LF CAL Adjustment	2-2
Mixer Balance Adjustment	2-3
Control Function and Operation	2-5
Mode Switch	2-6
Center Frequency	2-6
Dispersion	2-6
Resolution	2-6
Gain Controls	2-8
Video Filter	2-9
Calibration	2-10
Application	2-11
Distortion Analysis	2-11
Intermodulation Distortion Percentage	2-11
Transducer Distortion Analysis	2-12
Environmental Noise	2-12
Machinery Vibration Analysis	2-12
Vibration Testing	2-13
Frequency Response	2-13

	Page
SECTION 3                   CIRCUIT DESCRIPTION	3-1
General	3-1
Block Diagram Description	3-1
Detailed Circuit Description	3-2
Input Attenuator	3-2
Balanced Mixer	3-2
Range Attenuator	3-3
Crystal Filter	3-3
IF Amplifier	3-4
Log Circuitry	3-4
Local Oscillator and Reactance Tube	3-5
Power and Bias Circuitry	3-6
SECTION 4                   MAINTENANCE	4-1
Introduction	4-1
Confirmation	4-1
Isolation	4-2
Troubleshooting the Spectrum Analyzer	4-3
SECTION 5                   ALIGNMENT PROCEDURE	5-1
General	5-1
Local Oscillator	5-1
Dispersion	5-2
Log Scale	5-3
Input Attenuator Adjustment	5-3

## LIST OF ILLUSTRATIONS

Figure		Page
1-1	Spectral Display Characteristics	1-2A
2-1	Spectrum Analyzer Controls and Functions	2-5A
2-2	Resolution Conditions	2-7A
2-3	1 KC Side bands on a 10 KC Carrier	2-13A
2-4	Resolution Capability	2-13A
2-5	First, Third, and Fifth Harmonics of a 1 KC Square Wave Signal	2-13A
2-6	Response Curve of a Double Tuned Filter	2-13A
2-7	100 KC Signal Containing 1 Percent Sidebands (1 KC)	2-14A
2-8	100 KC Signal Containing 1 Percent Sidebands (1 KC) with Sidebands 30 db below Main Signal	2-14A
2-9	1 KC Signal with Spectrum Analyzer in FULL SCAN Mode	2-14A
2-10	Response of Transducer Secured to an Industrial Shake Table	2-14A
3-1	NELSON-ROSS Plug-In Spectrum Analyzer, Block Diagram	3-1A
5-1	NELSON-ROSS Plug-In Spectrum Analyzer, Internal Alignment Controls, Top Chassis	5-4A
5-2	NELSON-ROSS Plug-In Spectrum Analyzer, Internal Alignment Controls, Bottom Chassis	5-4B

## WARRANTY

NELSON ROSS ELECTRONICS, INC. warrants each instrument manufactured by it to be free from defects in material and workmanship for a period of one year after date of delivery to the original purchaser. Our liability under this warranty is limited to servicing or adjusting any instrument returned for that purpose and to the replacement of any defective parts thereof. This warranty does not cover fuses batteries and tubes. This warranty will be honored when the instrument is returned, transportation prepaid, and when examination proves to our satisfaction that the instrument is defective. Defects due to abuse, misuse or abnormal conditions of operation will be repaired at cost, upon approval of an estimate.

IN CASE OF FAILURE: notify us - be sure to include the serial number of the instrument.



|-|

SECTION 1  
CHARACTERISTICS

SCOPE

This manual provides Operating Instructions, theory of operation, Technical Characteristics, Maintenance, and Trouble Shooting Procedures for Nelson-Ross Plug-In Low Frequency Spectrum Analyzers Models 001, 011, 002, 012, 003, 013.

These Analyzers are designed to provide coverage of three frequency ranges; 10 cps to 20 kc, 35 cps to 100 kc, and 150 cps to 500kc. Models 011, 012 and 013 are provided with calibrated CENTER FREQUENCY and DISPERSION dials, while models 001, 002 and 003 are uncalibrated.

These units are designed so that they may be conveniently plugged into any Oscilloscope which accepts the TEKTRONIX letter series plug-ins. By simply installing one of these plug-in units, the Oscilloscope becomes a complete Spectrum Analyzer. In use, the sawtooth output of the Oscilloscope is utilized to provide a signal for sweeping the Spectrum Analyzer Oscillator. All voltages for Spectrum Analyzer operation are obtained automatically when the Analyzer is plugged into the oscilloscope.

## GENERAL INFORMATION

Before installing and operating a NELSON-ROSS Plug-In Spectrum Analyzer it is important to have a clear understanding of the nature and interpretation of the spectral display it will provide. The conventional use of an oscilloscope is to present a display of the amplitude/time characteristic of an electrical signal. In such a presentation the horizontal axis of the cathode-ray tube represents time and the vertical axis represents instantaneous amplitude. An equally meaningful display - commonly called a spectral display - is one in which the horizontal axis represents frequency and the vertical axis represents RMS amplitude. This is the type of display provided by NELSON-ROSS Plug-In Spectrum Analyzers.

The nature of the spectral display can be understood with the aid of the following illustrative examples;

- 1- on an ideal spectrum analyzer, a signal containing energy at only one frequency will appear as a single vertical line on the display. This is illustrated in figure 1-la.
- 2- multiple signals would then appear as multiple vertical lines, however close in frequency they may be. A carrier modulated by sidebands at plus and minus a small frequency increment would thus appear as in figure 1-lb.
- 3- since in real life nothing is ideal, a spectrum analyzer

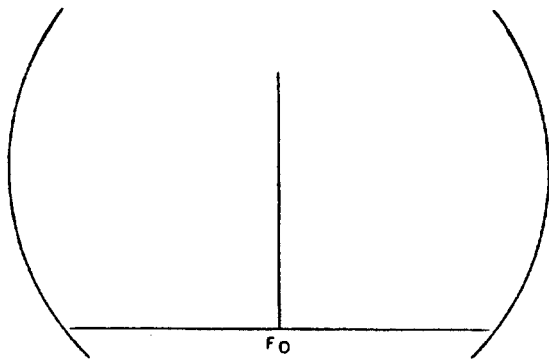

A— C W SIGNAL AS SEEN ON IDEAL SPECTRUM ANALYZER

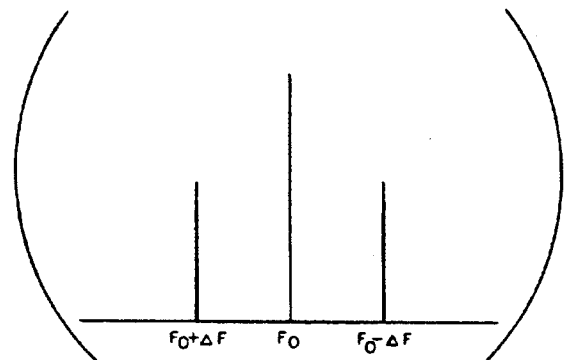

B— MODULATED SIGNAL ON IDEAL ANALYZER

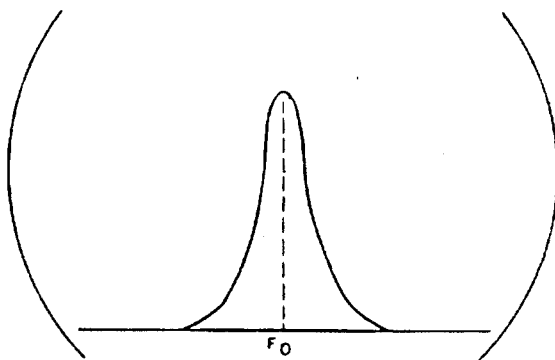

C— C W SIGNAL AS SEEN ON REAL ANALYZER

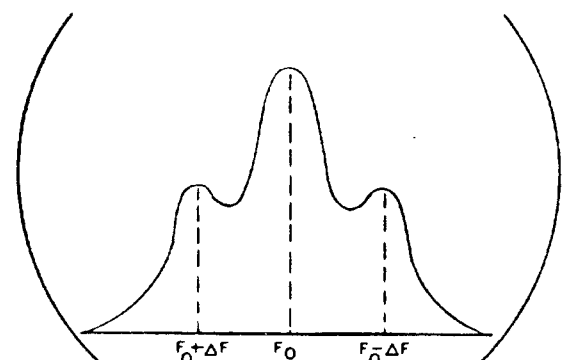

D— MODULATED SIGNAL ILLUSTRATING EFFECT OF RESOLUTION

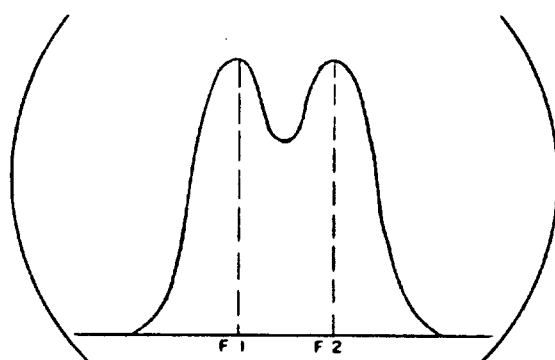

E— TWO EQUAL SIGNALS JUST RESOLVED

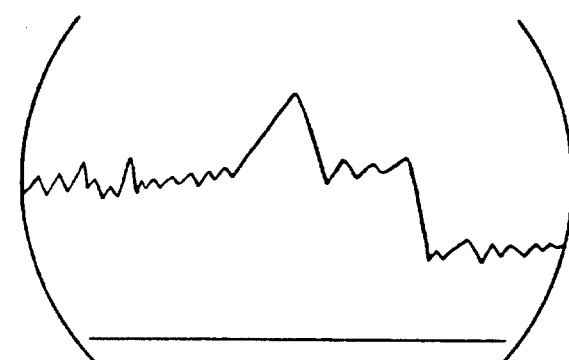

F— CONTINUOUS SPECTRUM

FIGURE I-1

SPECTRAL DISPLAY CHARACTERISTICS

cannot present an infinitely narrow vertical line. Instead the signal is broadened into a pulse as in figure 1-1c. Similarly, multiple signals closer together than the width of the pulse will tend to blend as in figure 1-1d. This illustrates a basic spectrum analyzer parameter which must be considered; resolution. The smallest frequency difference between two equal amplitude signals which can be displayed is defined as the resolution of the analyzer. Two equal amplitude signals are considered resolved when they are far enough apart to cause a 3 db dip to appear between them. This is illustrated in figure 1-1e.

4- signals containing components closer together than the resolution of the analyzer generate a continuous spectrum, as illustrated in figure 1-1f.

There are three basic parameters to any spectrum analyzer display. They are;

Resolution- as defined in the previous paragraph

Dispersion- the width of the display (in frequency)  
on the cathode-ray tube

Scan time- the amount of time taken to scan the dispersion  
mentioned above

Since the three parameters are interrelated it is important to understand the manner in which they effect one another. Scan time and dispersion may be combined to produce a factor called

Sweep Rate (cycles per second per second) which may not be exceeded for any given resolution. Expressed mathamatically;

$$\frac{\text{Dispersion}}{\text{Scan Time}} \leq (K) \text{ Resolution}$$

If this relationship is violated, either by reducing the scan time, increasing sweep speed or by increasing the dispersion, the signal will smear and lose amplitude. This is an important point to remember - contrary to conventional oscilloscope operation - with a spectrum analyzer slower sweep speeds produce better displays. Since NELSON-ROSS Plug-In Spectrum analyzers fit oscilloscopes with high sweep speed capabilities, the operator must remember to reduce the sweep speed sufficiently to obtain a good display. As a rule of thumb, the upper limit for any spectrum analyzer is 3-5 sweeps/second and many low frequency analyzers will require scan times in excess of 5 seconds.

The relationships mentioned above are of particular importance when making relative amplitude measurements. If the Scan Time, Dispersion or both are varied during a measurement-e.g. while searching for a harmonic or spurious signal - the sensitivity may vary. It is wise, therefor, to reduce the dispersion (or increase the scan time) until the signal amplitude is no longer attenuated by these effects before taking readings. As the dispersion is reduced (or the scan time increased) the amplitude of the component under observation will increase until a point is reached where further changes no longer have any effect. At this point a reading of amplitude may be taken.

CHARACTERISTICS

1-5

SPECIFICATION

PSA-001  
PSA-011

PSA-002  
PSA-012

PSA-003  
PSA-013

CENTER FREQUENCY RANGE	10cps to 20kc	35cps to 100kc	150cps to 500kc
TUNING DIAL RANGE (CALIBRATED)	0 to 20kc	0 to 100kc	0 to 500kc
TUNING DIAL ACCURACY	± 10 %		
MODES OF OPERATION	NORMAL: Tuning dial determines center frequency FULL SCAN: Entire band displayed on CRT. Mode selectable with front panel switch		
DISPERSION (SWEEP WIDTH)	100cps to 6kc	500cps to 30kc	2.5kc to 150kc
	Continuously variable with front panel calibrated control		
* DISPERSION ACCURACY	± 10 %		
RESOLUTION BANDWITH	10cps to 100cps	35cps to 250cps	150cps to 2kc
	Continuously variable with front panel control		
DISPLAY: INPUT VOLTAGE AMPLITUDE SCALES	Linear and 40 db Logarithmic		
SENSITIVITY	85 microvolts/cm. deflection (min.)		
NOISE LEVEL	Less than 10 microvolts referred to the input		
AMPLITUDE SCALE ACCURACY	Linear	± 10 %	
	Log	± 1 db	
AMPLITUDE RESPONSE	± 1 db		
SWEEP RATE	10/second to 50 seconds/scan Calibrated and variable		
INPUT ATTENUATOR	80 db range in 20 db steps		
INPUT IMPEDANCE	1 megohm		
DYNAMIC RANGE	Harmonic and IM products down 60 db		
INCIDENTAL FM	Less than 1% of narrowest Resolution Bandwith		
IF ATTENUATOR	40 db range in 20 db steps		
IF GAIN CONTROL	20 db: Continuously variable		
IF FREQUENCY	100kc	262kc	1.5mc
OSCILLATOR OUTPUT	1 volt peak-to-peak minimum from 4700 ohms BNC type connector on front panel		
OSCILLATOR FREQUENCY	120kc to 100kc	362kc to 262kc	2mc to 1.5mc
VIDEO FILTER (LOW PASS FILTER)	Four positions: 1, 3, 9, 66 milliseconds Selectable with front panel switch		
POWER REQUIREMENTS	All power and voltages from oscilloscope		
DIMENSIONS	Interchangeable with Tektronix Letter Series Plug-in Units		

\* Not applicable to PSA-001, PSA-002, PSA-003

## SECTION 2

### OPERATING INSTRUCTIONS

#### INSPECTION AND INSTALLATION

It is most important that a careful inspection be made of the unit immediately after it is unpacked. Look for obvious indications of any physical damage which may have been sustained during shipping. All tubes and crystals should be firmly seated in their respective sockets.

Insert the plug-in unit in to any oscilloscope which accepts the TEKTRONIX letter series plug-ins. Turn the knurled knob (at the bottom center of the analyzer) clockwise to secure the Plug-In Unit. Plug the cable emerging from the hole marked H SWEEP into the SWEEP OUTPUT jack on the scope panel.

#### INITIAL ADJUSTMENTS

Certain initial adjustments must be performed when installing the plug-in-unit for the first time. These initial adjustments must be made so that a true representation of control functions (presented in the next section) will be possible. Turn the oscilloscope power on, and allow a 15 minute warm-up period. The sweep controls on the TEKTRONIX Oscilloscope must be set to provide drive to the analyzer local oscillator, which will produce a free-running display at the proper sweep speed. To obtain a free-running display, set the oscilloscope controls as follows:

TRIGGERING MODE	AUTOMATIC
TRIGGER SLOPE	INT +

STABILITY	TURN FULLY CLOCKWISE
TRIGGERING LEVEL	0 (ZERO)
SWEEP SPEED CONTROL	50 MILLISECONDS/CM

Set the NORMAL/FULL SCAN switch on the analyzer in the FULL SCAN position. The ATTENUATOR range switch is set to the +80 position and the VERNIER GAIN Should be set to minimum (fully CCW). It will then be possible to obtain a horizontal trace along the bottom graticule line on the oscilloscope screen by adjustment of the V POS control. Position the trace by means of the oscilloscope HORIZONTAL position control so that the trace starts at the left hand edge of the CRT graticule.

#### LF CAL ADJUSTMENT

Since the voltages supplied to the analyzer may vary from oscilloscope to oscilloscope, an initial adjustment is required to bring the CENTER FREQUENCY and DISPERSION dials to the specified accuracy. Set the controls as follows:

ATTENUATOR	to 80 DB
DISPERSION	to (30% of maximum)
RESOLUTION	Minimum (Fully CCW)
VIDEO FILTER	LIN-1
MIXER BALANCE FINE	Centered
MIXER BALANCE COARSE	Centered
NORMAL-FULL SCAN	Normal
CENTER FREQUENCY	0 CPS



## NOTE

Any control not listed does not have an effect on these procedures.

A signal which may be anywhere from 10% of full scale amplitude to several times full scale amplitude, will appear on the screen. Using a screwdriver, adjust the LF CAL potentiometer to position the signal directly on the graticule center line.

## MIXER BALANCE ADJUSTMENT

Initial adjustment of the MIXER BALANCE controls is necessary, in order to minimize the leakage of any portion of the local oscillator signal through the mixer. When present, this leakage will appear as a signal at zero frequency on the oscilloscope display. In order to eliminate any unwanted signal proceed by setting the controls as follows:

ATTENUATOR to 80 DB  
DISPERSION to (fully CW)  
RESOLUTION Minimum (Fully CCW)  
VIDEO FILTER LIN-1  
MIXER BALANCE FINE Centered  
MIXER BALANCE COARSE Centered  
NORMAL-FULL SCAN Normal  
CENTER FREQUENCY 0 CPS

The ATTENUATOR RANGE and VERNIER GAIN Controls should then be adjusted to provide a visible signal amplitude on the oscilloscope.

screen. Rotate the DISPERSION control counterclockwise until a signal width covering a minimum of one quarter of the oscilloscope screen is obtained. This will provide greater adjustment accuracy.

The instrument is designed so that it will function properly around zero frequency only when set at maximum resolution. Decreasing resolution actually limits the minimum observable frequency. Set the resolution to maximum by rotating fully clockwise. Balancing is now accomplished by alternate adjustment of the MIXER BALANCE controls. Start by adjusting the COARSE control for a minimum signal, then adjust the FINE control. Alternate between COARSE and FINE until the best minimum is obtained. As the balance improves gradually increase the VERNIER GAIN and ATTENUATOR RANGE settings. All initial adjustments having been accomplished the instrument is ready for use.

#### NOTE

It is not necessary to achieve a perfect zero balance in order to use the instrument. The instrument will function perfectly with zero signals as large as 20 db above full scale present. The only effect of an excessive zero signal is to obscure low frequency components near the skirts of the zero signal. If difficulty is experienced in operating near zero, increase the input signal and reduce the vernier gain and range

attenuator settings, rather than trying to improve balance. This will increase the stability of the display. In any case, zero signals of  $\frac{1}{2}$  full screen amplitude are normal with the instrument set at full gain.

#### CONTROL FUNCTION AND OPERATION

In order to obtain the most efficient and accurate performance from any of the NELSON-ROSS Plug-In Spectrum Analyzer Units, it is essential that the function and marking of each of the controls be fully understood. Figure 2-1 contains a brief explanation of each control. The text portion of this section will present a further explanation of controls and the operational settings used during initial operation. The Spectrum Analyzer may be used in any application where the necessity exists to visually observe the frequency distribution of a signal. It is of course necessary that the signal or/components of the signals being observed fall within the frequency range of the plug-in analyzer. With the instrument, it is possible to measure the relative amplitudes as well as the absolute values of each of the various components which make up a complex signal. When the spectrum analyzer is used in conjunction with a synchronous signal generator (NELSON-ROSS models 101, 102 or 103) the frequency response of filters and amplifiers may be accurately determined.

... .. s

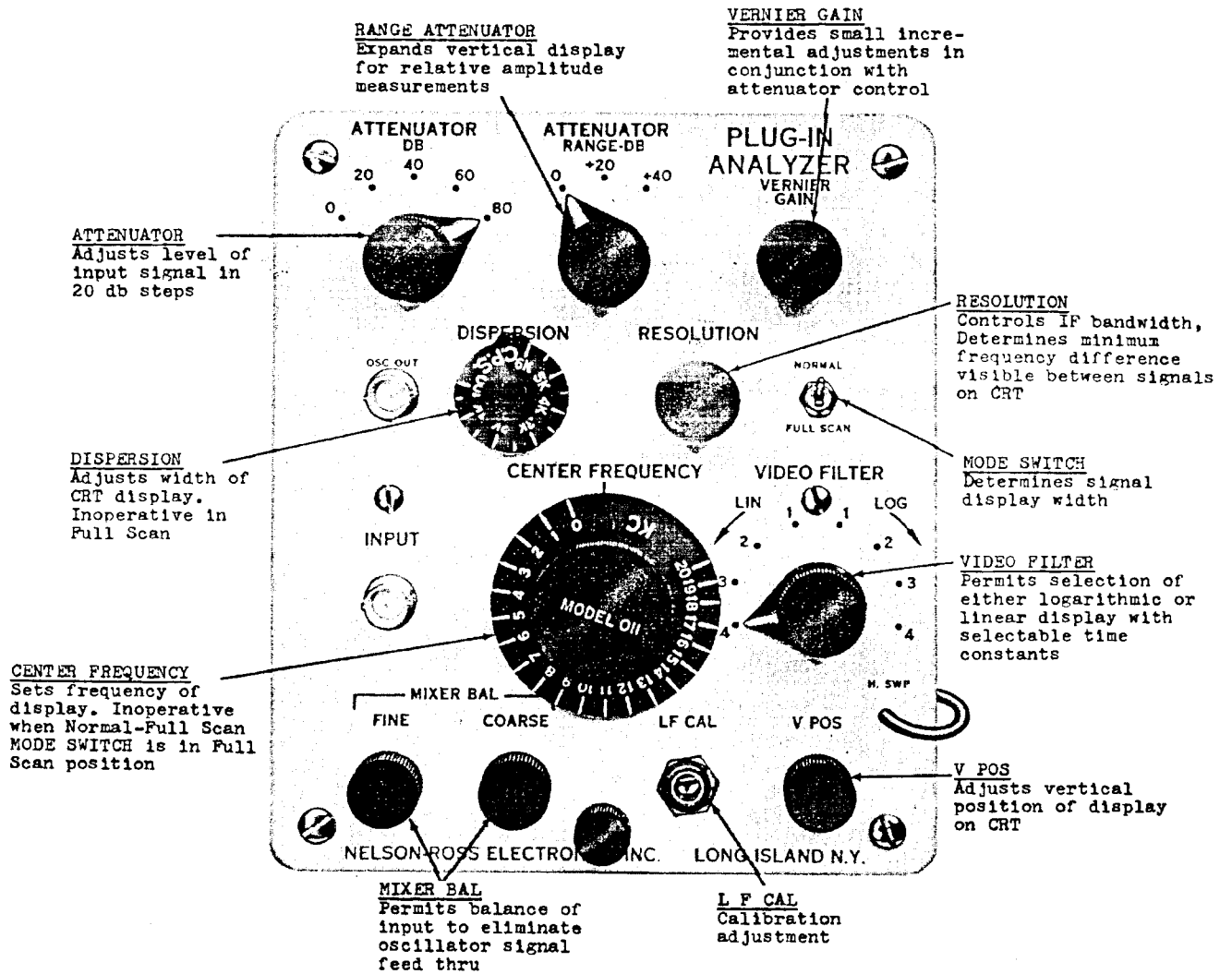

FIGURE 2-1

The spectrum analyzer is designed so that its basic operating characteristics may be adjusted to provide the parameters required for analysis of the desired signal. These parameters are adjusted thru the use of the following controls:

**MODE SWITCH**- This switch labelled NORMAL - FULL SCAN on the panel - determines whether the instrument operates as a tunable analyzer with adjustable dispersion, or as a fixed analyzer scanning the entire band. In FULL SCAN, the analyzer displays the entire band, with the zero frequency signal at the extreme right of the display and maximum frequency at the left. In NORMAL, the DISPERSION and CENTER FREQUENCY controls are operative. In all cases, the CRT spot travels from left to right, representing maximum frequency to zero.

**CENTER FREQUENCY** - Adjustment of this control centers the signal being observed on the oscilloscope screen. The MODE SWITCH (marked NORMAL and FULL SCAN) must be in the NORMAL position to permit tuning when using the CENTER FREQUENCY control.

**DISPERSION** - The position of this control adjusts the (frequency) width of the screen display. The MODE SELECTION switch marked NORMAL and FULL SCAN must be in the NORMAL position to permit tuning when using the DISPERSION control.

**RESOLUTION** - This control provides for the selection of the minimum difference frequency between two signals which may be observed on the screen. The minimum difference which is still usable on the display is known as the resolution. This difference is determined by the IF amplifier bandwidth of the analyzer.

Adjustment of the RESOLUTION control, varies the bandwidth (of the crystal filters) to provide the resolution required for the type of measurement being made. Two equal signals are considered resolved when a 3DB (or greater) dip is visible at their intersection. When making adjustments with the DISPERSION and RESOLUTION controls, it is advisable to keep in mind the fact that a combination of narrow resolution and wide dispersion will result in deterioration of sensitivity. This loss in sensitivity is due to the fact that the amplifier cannot respond to a signal which passes through it too rapidly. With proper use of the instrument this loss in sensitivity becomes negligible. When quantitative measurements are being made, it is necessary to prevent this type of variation in gain. Do not make changes in resolution or dispersion when measurements are being taken. It is to be noted that there is an optimum resolution setting for a particular value of dispersion and sweep rate. Whenever a resolution setting is too narrow in relation to the dispersion setting and sweep rate, filter ringing will occur. The ringing will be visible on the right side or trailing edge of the pulse. The ringing will proportionately decrease as the resolution is decreased (widened). A point will be reached where the ringing will disappear completely. For optimum resolution, the ringing should just barely be visible. The various resolution conditions are illustrated in figure 2-2. It will not always be possible to obtain optimum resolution, due to the fact that the instrument has been designed with a large dispersion range. When

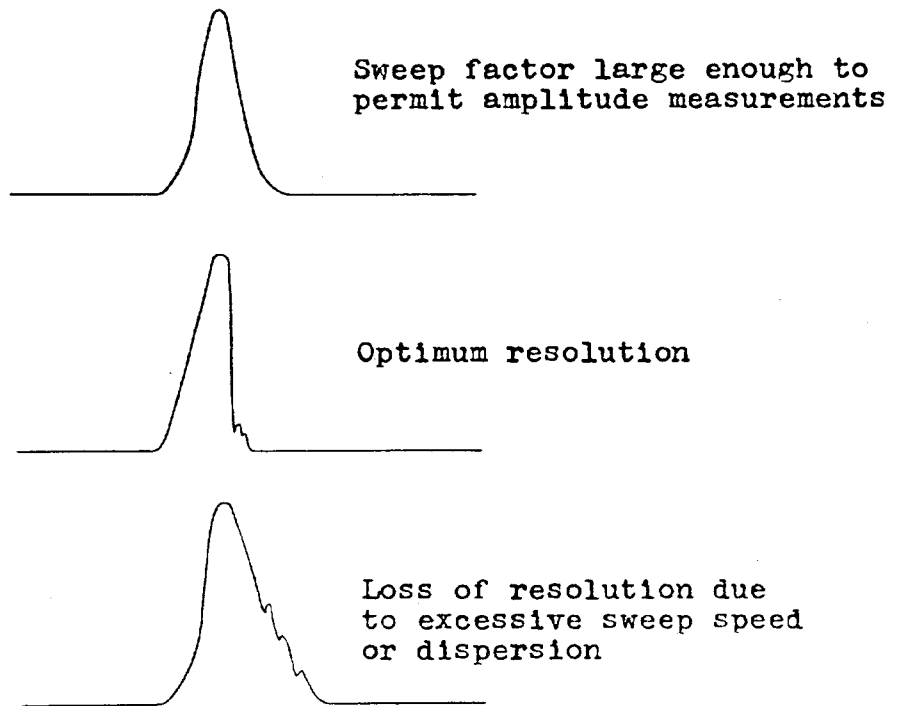

RESOLUTION CONDITIONS

FIGURE 2-2

the FULL SCAN mode is selected the sweep speed required is impractically slow. However, where very wide frequency scanning is used, optimum resolution is not required. In cases where signals are closely related (spaced at frequencies of the same order as the resolution), it will not always be possible to obtain optimum resolution.

GAIN CONTROLS - ATTENUATOR, ATTENUATOR RANGE and VERNIER GAIN controls serve very important and specific purposes. Basically, they adjust incoming signals to visible levels, and provide ranging for amplitude level measurements.

The ATTENUATOR RANGE control may be placed in one of three positions; 0DB, -20DB and -40DB. Signal ratio amplitudes of up to 20 DB may be read on the oscilloscope screen. Therefore, a total range of relative amplitudes of up to 60 DB may be measured. The amplifiers and associated circuitry following the attenuator have been designed with sufficient dynamic range to eliminate the possibility of generation of harmonics or circuit saturation providing the following precautions are observed:

When the ATTENUATOR RANGE control is set at the 40 DB position, ATTENUATOR and VERNIER GAIN

should be set so that the largest component of the observed signal has no greater than

full screen amplitude. It is then possible to set the ATTENUATOR RANGE control to any position without the possibility of intro-

ducing distortion. The ATTENUATOR RANGE control may be placed in one of three positions; 0DB, -20DB and -40DB. Signal ratio amplitudes of up to 20 DB may be read on the oscilloscope screen. Therefore, a total range of relative amplitudes of up to 60 DB may be measured. The amplifiers and associated circuitry following the attenuator have been designed with sufficient dynamic range to eliminate the possibility of generation of harmonics or circuit saturation providing the following precautions are observed:

When the ATTENUATOR RANGE control is set at the 40 DB position, ATTENUATOR and VERNIER GAIN should be set so that the largest component of the observed signal has no greater than full screen amplitude. It is then possible to set the ATTENUATOR RANGE control to any position without the possibility of intro-

ducing distortion. The ATTENUATOR RANGE control may be placed in one of three positions; 0DB, -20DB and -40DB. Signal ratio amplitudes of up to 20 DB may be read on the oscilloscope screen. Therefore, a total range of relative amplitudes of up to 60 DB may be measured. The amplifiers and associated circuitry following the attenuator have been designed with sufficient dynamic range to eliminate the possibility of generation of harmonics or circuit saturation providing the following precautions are observed:



the FULL SCAN mode is selected the sweep speed required is impractically slow. However, where very wide frequency scanning is used, optimum resolution is not required. In cases where signals are closely related (spaced at frequencies of the same order as the resolution), it will not always be possible to obtain optimum resolution.

GAIN CONTROLS - ATTENUATOR, ATTENUATOR RANGE and VERNIER GAIN controls serve very important and specific purposes. Basically, they adjust incoming signals to visible levels, and provide ranging for amplitude level measurements.

The ATTENUATOR RANGE control may be placed in one of three positions; 0DB, -20DB and -40DB. Signal ratio amplitudes of up to 20 DB may be read on the oscilloscope screen. Therefore, a total range of relative amplitudes of up to 60 DB may be measured. The amplifiers and associated circuitry following the attenuator have been designed with sufficient dynamic range to eliminate the possibility of generation of harmonics or circuit saturation providing the following precautions are observed:

When the ATTENUATOR RANGE control is set at the 40 DB position, ATTENUATOR and VERNIER GAIN should be set so that the largest component of the observed signal has no greater than full screen amplitude. It is then possible to set the ATTENUATOR RANGE control to any position without the possibility of intro-

ducing saturation or spurious harmonic signal errors. It is then essential that only the ATTENUATOR RANGE control be used to set measurement ranges. Any attempt to set range with the ATTENUATOR control increases the possibility of input amplifier overload, with resultant generation of harmonics products. These products will appear on the oscilloscope and lead to erroneous signal analysis.

The VIDEO FILTER control may be set in either of 4 linear positions or 4 logarithmic positions. In any of the 4 LIN positions, deflection on the oscilloscope screen will be directly proportional to the input signal amplitude. While in any of the 4 LOG positions the oscilloscope deflection will be proportional to the logarithm of the input signal amplitude.

It should be noted that similarly numbered positions are identical in both the LOG and the LIN settings. The numbered positions represent the selection of increasing values of integration time constants in the video output of the instrument. The video filters provide suppression of beat notes which occur when signals with close components are being observed. Since increased settings of the filter control requires slower sweep speeds, it is recommended that the control be set at its lowest practical number. When sweep speeds are excessive the amplitude of the pulse decreases and the right hand side of the trace will become distorted. This distortion is caused by integration of the signal.

## CALIBRATION

While a spectrum analyzer is not normally used for amplitude measurements, NELSON-ROSS PLUG-IN SPECTRUM ANALYZERS may be calibrated in order to provide accurate absolute, measurements of the components of any complex waveform. The voltage calibration circuitry of the Tektronix oscilloscope is quite adequate for such purposes. The Tektronix calibrator generates a square wave which is calibrated in a peak to peak voltage range of 200 microvolts to 100 volts. This square wave frequency is approximately 1000 cps.

Calibration is accomplished by visually observing the amplitude of the fundamental component of the square wave while simultaneously noting the deflection produced. The square wave is ideally suited for calibration techniques since fundamental component amplitude is independent of rise, fall, and tilt. The limiting case of a square wave is a sine wave of the fundamental amplitude resulting from increasing rise and fall times. The fundamental, being much lower in frequency than all other signal components, is quite easily identified.

Fourier analysis indicates the RMS amplitude of the fundamental as:

$$E_{\text{rms}} = (1.414/\pi) E_{\text{p-p}} \text{ sq. wave}$$

and

$$E_{\text{p-p}} = (4/\pi) E_{\text{rms}} \text{ sq. wave}$$

It is helpful to remember that the RMS sensitivity of the instrument is 0.45 times the peak-to-peak oscilloscope calibrating voltage. In addition the peak-to-peak sensitivity is

equal to 1.28 times the peak-to-peak calibrator output.

Whenever performing calibration of the instrument be aware of the fact that sensitivity varies with different values of resolution and dispersion as mentioned in section 1. Therefore, calibration and measurement must be made while observing the precautions mentioned in that section. It is possible to calibrate the instrument within 10% accuracy. This degree of accuracy results from the fact that the Tektronix calibrator is accurate to within 3% while the conversion figures indicated in the above paragraphs are within 5%. The other 2% results from reading error.

#### APPLICATION

The NELSON-ROSS series of Plug-In Spectrum Analyzers are capable of performing in a multiplicity of applications. The following paragraphs and illustrations are but a few examples of possible instrument applications.

**DISTORTION ANALYSIS** - The percentage of distortion products of both amplifiers and oscillators may be determined by using an instrument operating within the desired range. Examination of the input signal is first made. Quality and harmonic content are observed. The output of the unit under test is then observed. Performance is determined by subtracting the input harmonic content from the output harmonic content.

**INTERMODULATION DISTORTION PERCENTAGE** - Measurement is made by using a two-tone oscillator to drive the unit under test. In

addition it's possible to use two oscillators which are fed into a resistive mixer coupled to the input of the unit. The sum and difference signals in the output are then measured in relation to the fundamental outputs.

**TRANSDUCER DISTORTION ANALYSIS** - The distortion present in sonar transducer and loudspeakers is measured as follows: The loudspeaker or sonar transducer under test is placed in a suitable chamber. In the case of the sonar transducer, it would be located in a pond. The output signal is then detected by a microphone or other type of transducer device. Examination of the input signal is then made to determine spectral purity. The output signal is then observed. Comparison of the input and output signal for harmonic content provides distortion information.

**ENVIRONMENTAL NOISE** - By observing the output from a microphone connected to the input of the instrument, the frequency distribution of factory machinery or office noise may be measured.

**SONAR ANALYSIS** - The instrument may be used to determine frequency distribution, frequency modulation and wasted sideband energy of sonar transmitters. The driving signal may be observed directly, or the measurement may be made in a water environment thru the use of a suitable transducer pick-up. The instrument's high input impedance permits use of a wide variety of detectors.

**MACHINERY VIBRATION ANALYSIS** - By mounting an accelerometer on the motor or machinery under investigation it is possible to

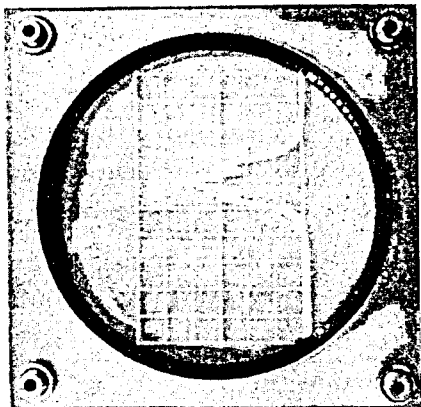

2-4

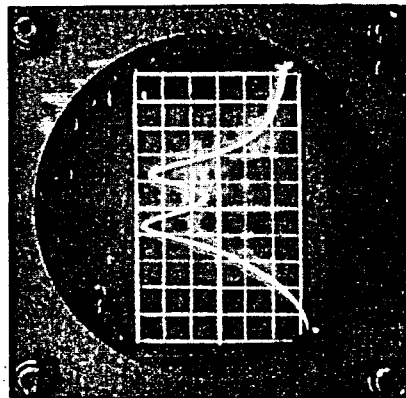

2-6

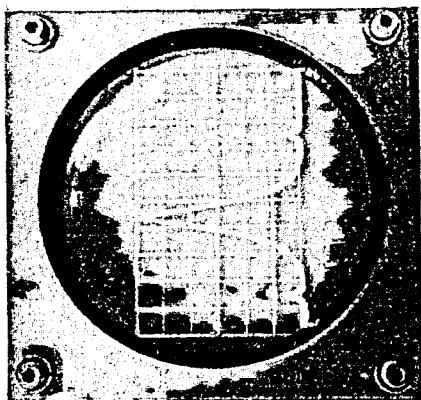

2-3

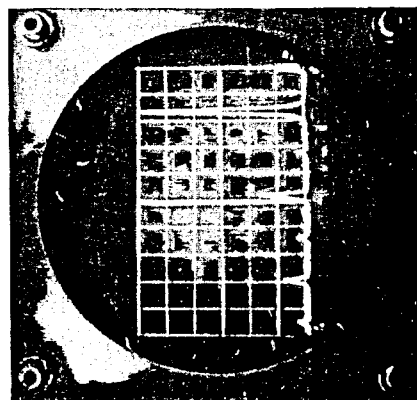

2-5

FIGURES 2-3 to 2-6

TYPICAL DISPLAYS (see text)

- 2-5 Model 011 - the first, third and fifth harmonics of a 1 KC. square wave SIGNAL are visible in this figure. The MODE switch is in the NORMAL position and the VIDEO FILTER is in the LIN-1 position. In this display, ZERO signal is at the extreme right. The large portion of the SIGNAL is the first (fundamental) harmonic at 1 KC. The DISPERSION control is set at 6 KC.
- 2-6 Model 012 - This display demonstrates the response curve of a double tuned filter. The input to the filter is provided by a SYNCHRO-SWEEP generator. The generator supplies a swept zero to 100 KC SIGNAL (or ZERO to the maximum range of the spectrum analyzer),  $\pm 1$  DB. in amplitude. Using the FULL SCAN MODE, and with the VIDEO FILTER in the LIN-1 position, complete filter characteristics may be demonstrated.
- 2-7 Illustration of 100 KC. SIGNAL containing 1 percent sidebands (1 KC). The sidebands are 50 DB down from the 100 KC signal. The MODE switch is in the NORMAL position, and the VIDEO FILTER is in the LIN-1 position.
- 2-8 The signal input in this display is the same as that of figure 2-7. However, the VIDEO FILTER is in the LOG-1 position, illustrating compression with the sidebands 30 DB below the MAIN SIGNAL.
- 2-9 Model 011 - In this display, a 1 KC signal is shown with the MODE switch in the FULL SCAN position. The ZERO SIGNAL and the first through the tenth harmonic are visible. All harmonics are odd.

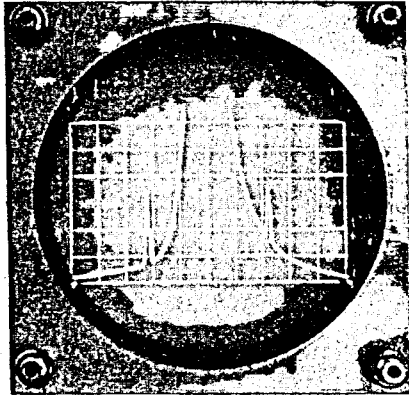

2-7

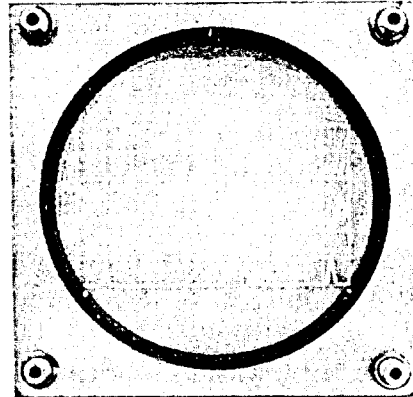

2-8

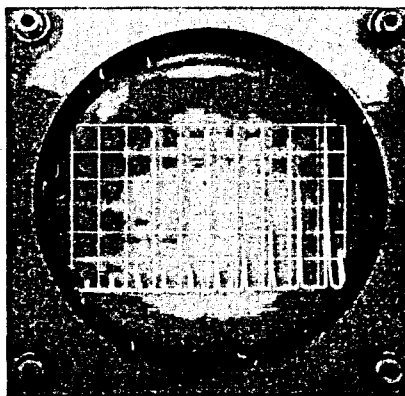

2-9

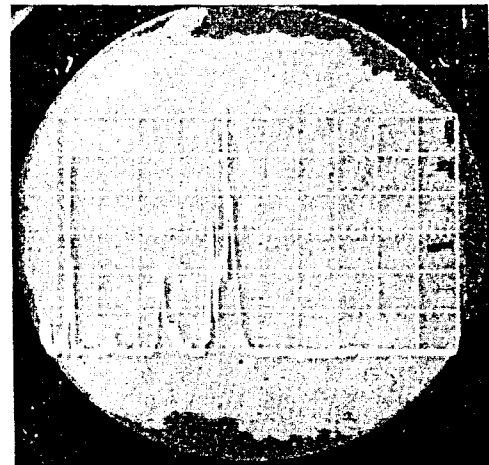

2-10

TYPICAL DISPLAYS (see text)

FIGURES 2-7 to 2-10



2-10 Model 011 - This illustration shows the response of a transducer which has been secured to an industrial Shake Table. The MODE switch is in the NORMAL position. Use is made of 6 KC. dispersion, centered at 3 KC. This figure demonstrates the relative amplitude of vibrations at frequencies from ZERO to 3 KC. Equipment for this demonstration was as follows:

A Glennite Accelerometer MODEL A321TMV S/N 509 was used as the transducer. The scale factor shows approximately 2.3 G's (at the maximum) occurring at approximately 2.5 KC.

## SECTION 3 CIRCUIT DESCRIPTION

## GENERAL

The circuit description presented in this section applies to NELSON-ROSS Plug-In Spectrum Analyzers Models 001, 002, 003, 011, 012, and 013, with certain minor component reference exceptions. These exceptions will be noted whenever they occur in the detailed circuit description.

## BLOCK DIAGRAM DESCRIPTION

Figure 3-1 is a block diagram representation of the circuitry in the NELSON-ROSS Plug-In Spectrum Analyzer.

The input signal first passes through the input attenuator where the desired level is adjusted. The attenuated input signal is then routed through the balanced mixer. The input signal is mixed with an internally generated, swept local oscillator signal in the balanced mixer. Oscillator spurious products and modulation products are suppressed, while the sum and the difference frequency signals are complemented. This resultant signal then passes through the range attenuator and the crystal filter. The frequency response of this filter may be varied in order to provide the required degree of signal resolution on the screen of the oscilloscope. The signal output from the filter drives the IF amplifier. Most of the instrument gain is provided by the amplifier. The IF amplifier is tuned to the sum frequency of the mixer output. At this point, the output of the IF amplifier is directed through two separate and independent

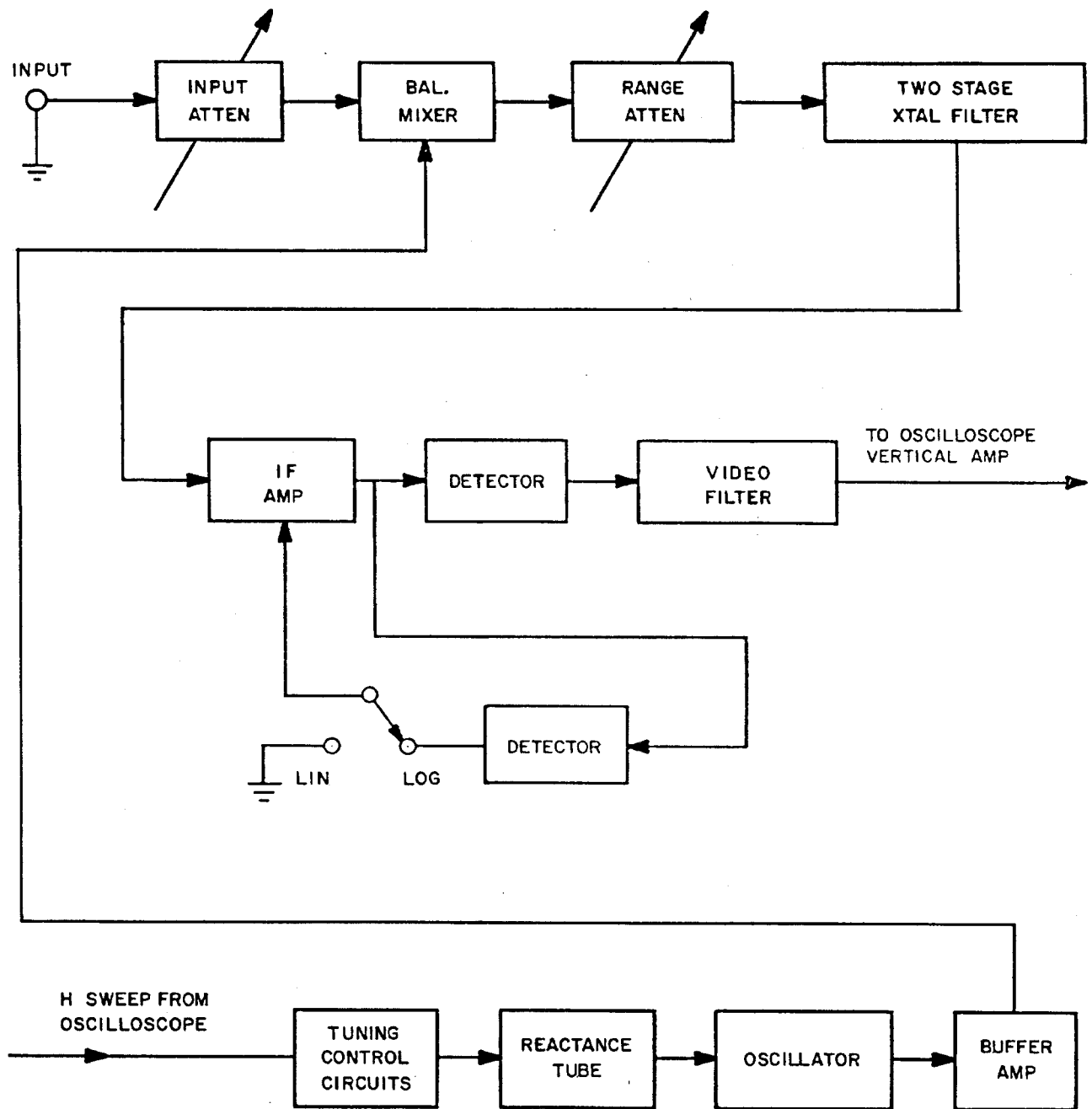

BLOCK DIAGRAM

FIGURE 3-1

detectors. One detector output passes through a video filter to the oscilloscope vertical amplifier. The output of the second detector provides a feedback signal which is used to generate a log function. When the video filter is in any of the LIN function positions, this feedback signal is not utilized.

The sawtooth output of the oscilloscope is utilized to drive a reactance tube. The reactance tube sweeps the local oscillator in synchronism with the oscilloscope trace. Reactance tube drive is furnished through the tuning control circuits.

#### DETAILED CIRCUIT DESCRIPTION

##### INPUT ATTENUATOR

An input signal (within the frequency range of the plug-in unit) is connected at J1. The signal passes through the input attenuator, providing attenuation of up to 80 Db in 20 Db steps. In order to insure flat attenuation for the frequency ranges covered by Models 002, 012, 003 and 013, compensation is provided by placing trimmer capacitor across certain resistors.

##### BALANCED MIXER

The selectively attenuated signal is then fed to a balanced mixer consisting of tubes V1, V2 and V3. In V1, the signal is converted into a push-pull voltage and the derived voltage is utilized to drive the grids of V2 and V3. Tubes V2 and V3 are connected in a push-pull configuration relative to the input signal, and they are in a push-push configuration in relation to the local oscillator.

The local oscillator is connected to the paralleled cathodes of V2 and V3. As a result of the outputs of V2 and V3 being connected in push-pull, the oscillator signal will cancel out in coil Z1. Since the signal frequencies are far removed from the resonant frequency of Z1, they will not appear in the output. The local oscillator is large enough to cause tubes V2 and V3 to be driven into the non-linear region of their characteristics, causing mixing action between signal and local oscillator. The resultant sum frequency is selected by Z1 for amplification by the IF amplifier system.

#### RANGE ATTENUATOR

The output of Z1 is single ended with respect to ground. The RANGE ATTENUATOR provides three settings: - straight thru (0 DB), 20 DB and 40 DB. In some models the range attenuator is isolated from the secondary by  $\frac{1}{2}$ V4 connected as a cathode follower. In other models the secondary of Z1 drives the RANGE ATTENUATOR directly and  $\frac{1}{2}$  of V4 is connected as the first IF amplifier.

#### CRYSTAL FILTER

The output of  $\frac{1}{2}$  of V4 and the triode section of V5 are utilized to drive the two sections of the crystal filter network. Resolution is determined by the combined bandwidth the two crystal filter sections. Bandwidth of each filter section is determined by shunting the transformer in each section with a potentiometer. By changing the value of resistance across each transformer, the effective "Q" of Z2 and Z3 is changed. As a result, the filter bandwidth around the I.F. frequency is also varied. This band-

width determines the resolution of the plug-in unit. Dual potentiometer R32 (resolution) simultaneously varies the "Q" of Z2 and Z3. Capacity across each of the crystal holders is neutralized by adjustment of trimmer capacitors C12 and C16.

#### IF AMPLIFIER

The IF amplifier is composed of two double tuned stages consisting of V8 and V9. The majority of plug-in unit gain is provided by this circuit. VERNIER GAIN adjustment is accomplished by varying the D.C. operating point of V8. This operating point is determined by changing the cathode bias. Cathode potentiometer R66 (VERNIER GAIN) controls the level of cathode bias. With the exception of the log feedback detector, the amplifier circuitry is quite conventional. The output of V9 is a DC voltage which appears only when an I.F. signal is present. The output of V9 is detected by diode CR1. The detected signal is then fed to the oscilloscope vertical input through an integrating network consisting of resistors R81 and R82, capacitor C43 the LOG-LIN switch assembly.

#### LOG CIRCUITRY

Log scale generation is accomplished by utilization of a feedback signal to control the GAIN of V9. The IF signal is detected from the plate of V9 and the resultant voltage is fed back to the grid of V9 as a bias voltage. V9 has a remote cut-off characteristic especially applicable to this circuit. As the input increases, the detected bias also increases. The result is a decrease in the gain of the stage. The pentode-diode

characteristics of V9 determine the logarithmic pattern of the oscilloscope display. The decibel range is controlled by varying the setting of the diode output divider R76 (DB RANGE). The DB shape potentiometer (R72) varies the screen voltage. Any change in this screen voltage has a direct effect on the operating point and the slope characteristics of the tube. Adjustment of this potentiometer provides the desired log shape.

#### LOCAL OSCILLATOR AND REACTANCE TUBE

Dual triode V6 serves as both a Hartley oscillator and a reactance tube. Coil Z4 provides resonant tank circuit inductance. The reactance circuit is conventional in design. Capacitor C19 provides only a portion of the resonant capacitance of the tank circuit (in some units C19 is the stray grid-plate capacity of V6). This capacitance is multiplied by the gain of the stage. The capacity seen by the oscillator tank is therefore proportional to the  $G_m$  of the tube. When the plate current on the tube is varied (by changes in the sawtooth drive present on the grid) the  $G_m$  of the tube changes. As a result of this change in  $G_m$ , the local oscillator frequency changes. Adjustment of inductance Z4 or RT ADJUST potentiometer R48 will determine the oscillator sweep frequency range with the full sawtooth input. In the NORMAL mode, the reactance tube grid voltage, and therefore the oscillator frequency, is determined by CENTER FREQUENCY and, DISPERSION potentiometer settings. The dispersion setting controls the level of the sawtooth signal which is superimposed on the DC level present on the center frequency potentiometer. The

oscillator sweep frequency is thereby limited by the DC sawtooth limits. The end result is "DISPERSION" or ("frequency-window") which appears across the oscilloscope screen. Potentiometer R89 acts as a tuning control. This control provides a voltage which is directly dependent upon the frequency setting of the CENTER FREQUENCY dial. This dial determines the oscillator center frequency. The sawtooth which is provided by the oscilloscope circuitry is selectively attenuated by the DISPERSION control R103. The signal is now summed by the network consisting of resistors R43 and R44. The resultant signal is coupled to the grid of the reactance tube. In the FULL SCAN position, the tuning control is by-passed and the entire sawtooth signal is presented to the summing network. This results in a sweep over the entire band.

#### POWER AND BIAS CIRCUITRY

All operating voltages required for plug-in unit operation are secured from the oscilloscope's internal power supplies. In order to insure a high degree of regulation over a wide range of operating conditions, all unused supplies (within the oscilloscope) are loaded to their minimum requirements. Positive bias for the grids of the oscilloscope amplifier is provided by the divider network consisting of R84, R86, R87, R79 and R83.



## MAINTENANCE

## SECTION 4

## INTRODUCTION

In the design and construction of the NELSON-ROSS Plug-in Spectrum Analyzers, much emphasis has been placed upon high reliability and minimum down-time. However, any piece of electronic equipment will require a certain amount of maintenance thru normal usage. With this in mind, the following maintenance information is provided in this section. In the event of the occurrence of a malfunction in the Spectrum-Analyzer system, it is recommended that the trouble be corrected by following four general steps:

1. Confirmation that a malfunction actually does exist.
2. Isolation of the trouble to either the plug-in Spectrum Analyzer unit or the oscilloscope main frame.
3. Trouble-shooting the plug-in unit to determine the exact source of trouble.
4. Repair the malfunction.

## CONFIRMATION

It has been found thru experience that many indications which are presumed to be caused by a malfunction in the equipment actually result from incorrect control settings. All controls should be checked for correct settings. As an example, if the VIDEO FILTER is in the circuit, and the SWEEP SPEED is set at too high a level the trailing edge of the display will distort to the point of being un-usable. Excessive sweep speed will also cause the display to shift, thus resulting in erroneous frequency readings.

A combination of the above errors in control settings will also result in an incorrect amplitude display. Once determination is made that an actual equipment malfunction does exist, it must be ascertained whether it is located in the plug-in unit or the oscilloscope main frame.

#### ISOLATION

Isolation of the trouble to either the oscilloscope or the plug-in unit may be accomplished by either of two possible methods. In the first and simplest method, the plug-in unit is removed and replaced with a spare plug-in. The second method requires verification of input signals, supply voltages, and analysis of the screen display.

#### CAUTION

Before plugging in the spare unit, it is essential that a careful inspection be made of the suspected original unit, for evidence of charred components or burned wiring. Any indications of such damage could be the result of excessive oscilloscope supply voltages. In such cases it is absolutely necessary to make complete voltage checks prior to installing a spare. If this precaution is not taken, the spare unit may become damaged.

If, after a spare unit (known to be functioning properly) is substituted the system does not work properly, the fault exists in the oscilloscope. Refer to the oscilloscope instruction manual for correct maintenance procedures. In a case where a spare unit is not available for substitution further testing must be performed. It will be necessary to use a plug-in extension cable (available from the oscilloscope manufacturer) to facilitate the required testing.

First, check all voltages supplied by the oscilloscope to the plug-in unit. If the voltages measure incorrectly, remove the plug-in Spectrum Analyzer and re-check the voltages. At this point, if the voltages check correctly with the Spectrum Analyzer removed, the trouble may be assumed to be in the plug-in unit. Verification must be made that the sawtooth input from the oscilloscope is present, and that it meets the oscilloscope manufacturers specifications (zero V to 150V). The horizontal trace must also appear on the oscilloscope display. If both of these conditions are met the Spectrum Analyzer may be considered to be malfunctioning.

The voltages indicated on the schematic diagram and the tube chart are nominal, with the exception of the supply voltages which are of close tolerance. The other, "Nominal" voltages may vary considerably in each instrument.

#### TROUBLESHOOTING THE SPECTRUM ANALYZER

When it has been definitely established that the malfunction exists in the Spectrum Analyzer, plug-in unit, the following

trouble shooting procedures are recommended.

Much time and effort will be concerned by first performing a very thorough visual inspection of the plug-in unit. Carefully scrutinize the unit for evidence of, burned or broken wires, defective switches, overheated or discolored components, and loose or improperly seated tubes and crystals. In the event that a burned or discolored component is discovered, (thru visual inspection) it is essential that the direct cause of the trouble be located, and corrected before replacing the component.

One very common source of trouble may be attributed to faulty vacuum tubes. If a visual check fails to reveal the cause of the trouble, it is recommended that all tubes be checked by the substitution method. Tube checks made by the tube tester method are not to be relied upon because of the wide tube operating parameters. Tubes which are found to be operating correctly should be returned to their original sockets. This will eliminate a great deal of necessary recalibration, usually resulting from variable tube characteristics.

If, after visual examination and tube substitution, the trouble still is not located, the Spectrum Analyzer circuitry should be checked by making careful voltage and resistance measurements at the points indicated on the schematic diagram and the tube voltage chart figure.

## SECTION 5 ALIGNMENT PROCEDURE

GENERAL

This section provides the complete procedure for aligning the NELSON-ROSS PLUG-IN SPECTRUM ANALYZERS Models 001, 002, 002, 011, 012 and 013. These instructions, when followed in the proper sequence, also furnish a method of separating any troubles which may occur. Therefore, this procedure can be used when troubleshooting the Spectrum Analyzers.

LOCAL OSCILLATOR

The three adjustments which affect the local oscillator are interacting. Therefore, the procedure must be repeated until satisfactory adjustment is obtained. Adjustments will be made as follows:

- 1) Connect a calibrated signal generator to the front panel INPUT connector on the Spectrum Analyzer. Set the signal generator to the upper frequency limit of the unit being aligned and adjust for a 5 millivolt output.
- 2) Set the Spectrum Analyzer in the FULL SCAN mode. Set both ATTENUATOR controls to 0 db and rotate the VERNIER GAIN control fully counterclockwise.
- 3) Position the VIDEO FILTER control to LIN-1. Set the RESOLUTION control for minimum resolution and rotate both of the MIXER BAL controls fully counterclockwise.
- 4) In the FULL SCALE mode, the Spectrum Analyzer should display its full frequency range. The zero frequency signal (oscillator leakage) should be at the extreme

right side of the oscilloscope graticule. The input from the signal generator should appear at the extreme left side of the oscilloscope graticule. Coil Z4 and RT ADJ potentiometer R48, shown in figure 4-3, are used to adjust the two limits. Z4 determines the frequency; potentiometer R48 affects amount of scan and the frequency. Z4 and R48 should be alternately adjusted until the full scan range is properly set.

- 5) Set the Spectrum Analyzer in the NORMAL mode and rotate the CENTER FREQUENCY control (tuning dial) to the highest frequency of the Analyzer. Adjust Z4 until the high frequency signal is centered on the oscilloscope.
- 6) Set the Analyzer back to the FULL SCAN mode of operation. Adjust FULL SCAN CENTERING control R107 until the display is centered on the oscilloscope screen.
- 7) Return the Analyzer to the NORMAL mode of operation. Check the divisions on the tuning dial against the settings on the signal generator to insure correct dial calibration.
- 8) Repeat, as necessary, steps 1 through 7 so the Spectrum Analyzer operates according to specifications.

#### DISPERSION

- 1) Rotate the DISPERSION dial to  $\frac{1}{2}$  maximum dispersion and set the CENTER FREQUENCY dial to mid-frequency. Using a signal generator, vary the input to measure the

actual dispersion across the oscilloscope screen. Adjust DISP. SET control R9, shown in figure 4-3, until the dispersion is within the specification limits. Check and readjust, as necessary, for maximum and minimum DISPERSION dial settings.

#### LOG SCALE

Connect a signal generator with a calibrated attenuator to the INPUT connector of the Spectrum Analyzer. Tune the signal generator to the center of the Analyzer tuning range; tune the Analyzer to display the output. Alternately adjust DB RANGE R76 and DB SHAPE R72, shown in figure 4-3, to obtain the correct 40 db scale curve on the display. The correct 40 db scale is 1/4 display change in amplitude for each 10 db input signal level change. The DB RANGE control sets the curvature of the scale, while the DB SHAPE control varies the amplitude of the curve. If difficulty is experienced in obtaining the correct curve, electron tube V9, shown in figure 4-3, should be replaced. Since the controls interact it is necessary to repeat the adjustments until satisfactory performance is obtained.

#### INPUT ATTENUATOR ADJUSTMENT

NOTE: This procedure applies only to 002, 012, 003 and 013 models.

- 1) Using the signal generator, insert a signal that is 10% of the maximum frequency of the analyzer. Check each attenuator section by adding 20 db attenuation while

increasing the input by 20 db. For each position that has a variable capacitor on the attenuator, tune the capacitor until the attenuation in that position is within specifications.

- 2) Repeat step 1 for an input signal of maximum frequency.



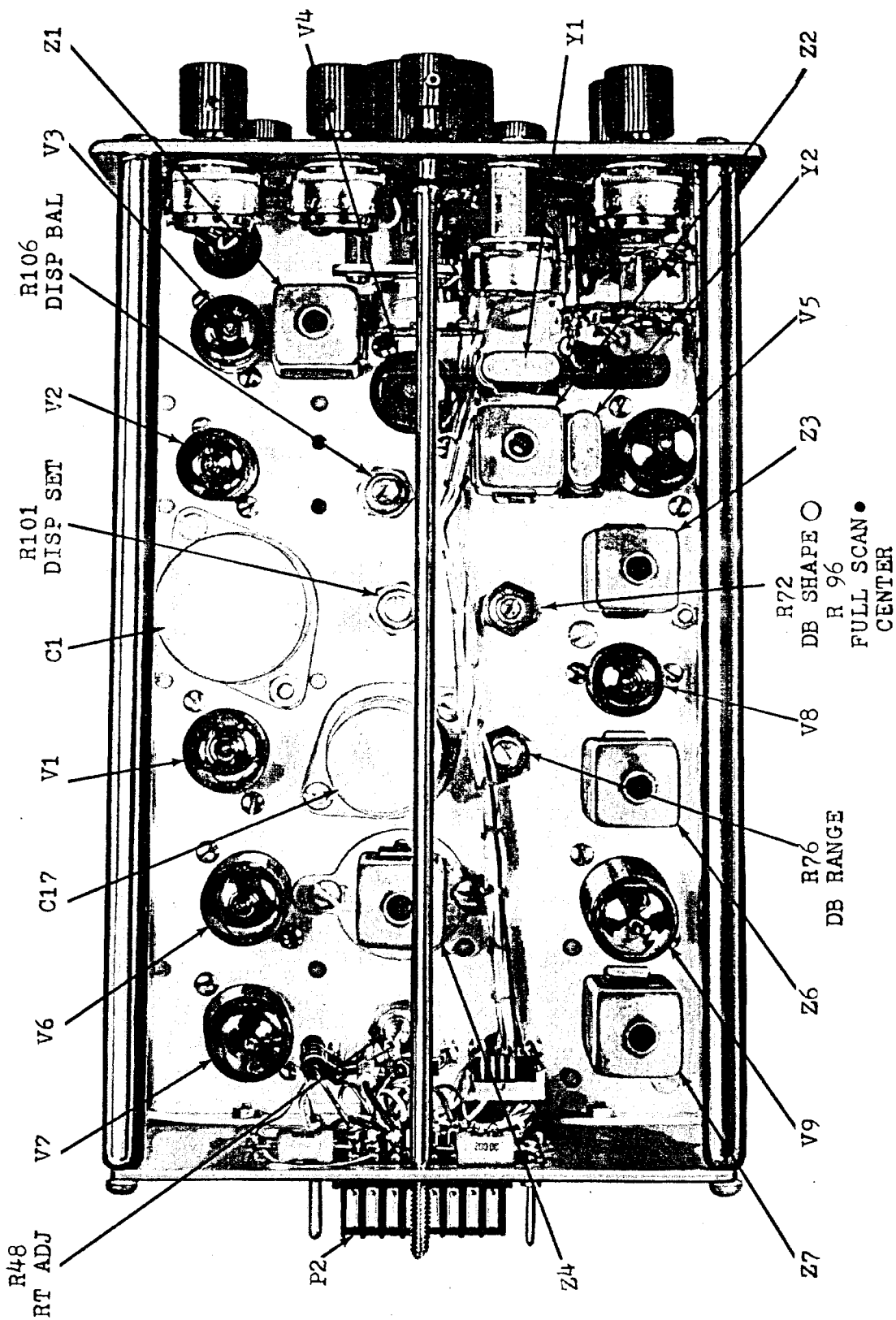

FIGURE 5-1

INTERNAL ALIGNMENT CONTROLS  
TOP CHASSIS

INTERNAL ALIGNMENT CONTROLS  
BOTTOM CHASSIS

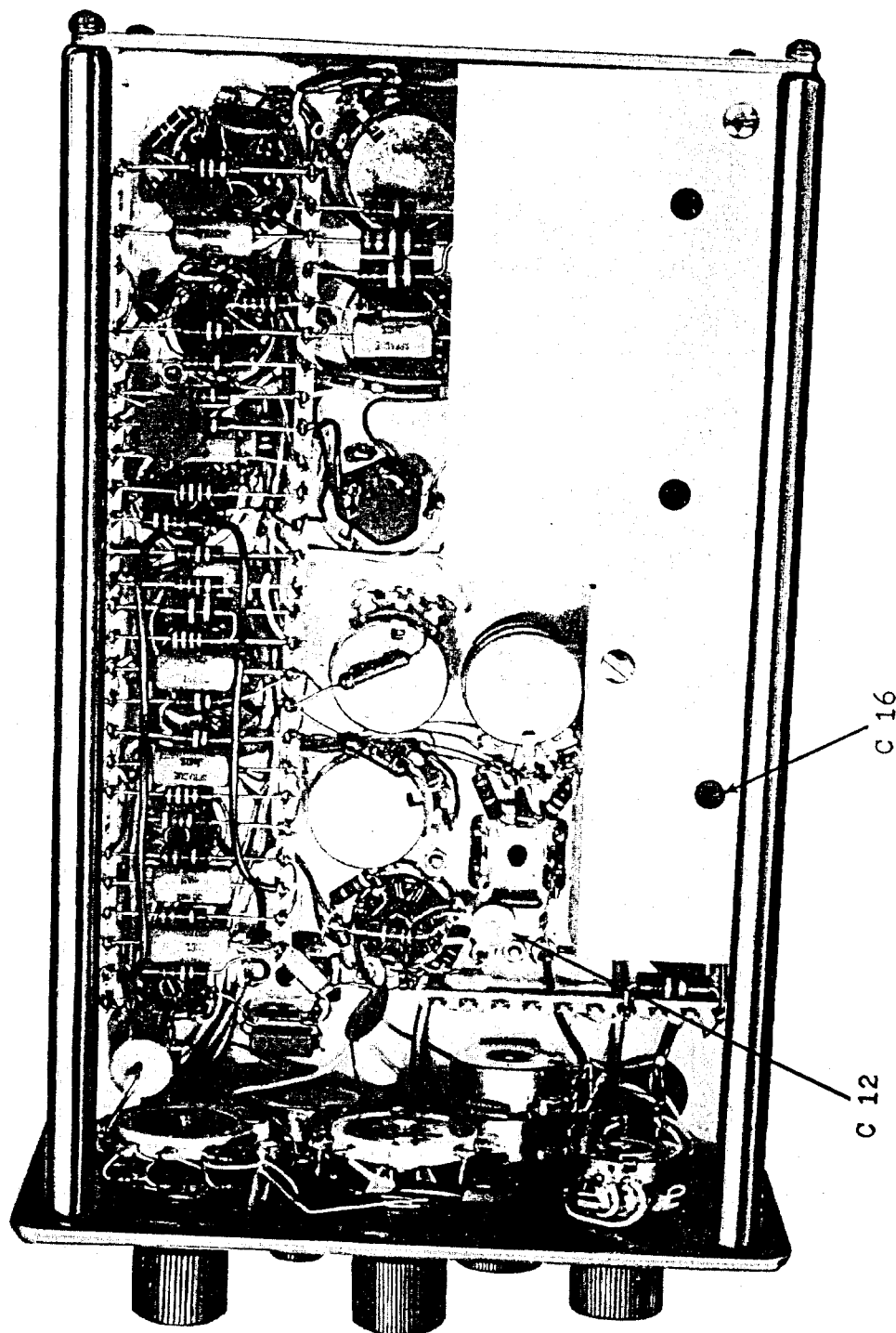

FIGURE 5-2

## VOLTAGE CHART

The voltages given in the following chart are given as a guide to normal performance. These voltages are typical for all models listed in this manual and may vary slightly for each model. Controls should be set as shown below.

MODE SWITCH: Full Scan

MIXER BAL: (Coarse & Fine) Centered or adjusted for balance.

CENTER FREQUENCY: Center of frequency range.

RESOLUTION: Fully clockwise

DISPERSION: Fully counterclockwise

VERNIER GAIN: Fully clockwise

ATTENUATOR (Input): Max attenuation

ATTENUATOR (Range): Max. attenuation

VIDEO FILTER: Lin 1

V POS: Center trace on CRT screen

LF CAL: Centered

ALL VOLTAGES ON FOLLOWING CHART WERE  
MEASURED USING 20000 OHMS PER VOLT METER

### VOLTAGE CHART

TUBE	PIN NUMBER								
	1	2	3	4	5	6	7	8	9
V1 5879	0	NC	7	25	30	NC	170	190	7
V2 6BH6	-.2	1.3	30	36	120	62	1.3		
V3 6BH6	-.2	1.3	36	42	120	62	1.3		
V4 12AT7	160	0	1.4	54	42	155	0	1.3	NC
V5 19EA8	135	NC	NC	74	54	0	NC	1.8	0
V6 6Z01	165	4*	8*	0	12	100	-.5	+3	NC
V7 12AT7	170	-2.0	0	12	24	24	-.3	0	NC
V8 6AU6	0	1.5	6.3 AC	95	205	115	1.5		
V9 6BY8	0	0	.1	95	6.3 AC	-.2	270	100	1.1

\* AC component on DC level

PARTS LIST  
MODELS PSA - 001, 011

ITEM	DESCRIPTION	DRAWING NO.
R1	Resistor $\frac{1}{2}$ W 10% 22K	
R2	Same as R1	
R3	Same as R1	
R4	Resistor $\frac{1}{2}$ W 10% 100K	
R5	Not used	
R6	Resistor $\frac{1}{2}$ W 10% 1500 ohms	
R7	Resistor $\frac{1}{2}$ W 10% 2.2M	
R8	Resistor $\frac{1}{2}$ W 10% 470 ohms	
R9	Same as R7	
R10	Not used	
R11	Resistor $\frac{1}{2}$ W 10% 39K	
R12	Potentiometer 50K Multiturn	C1000-154-24
R13	Same as R11	
R14	Same as R4	
R15	Not used	
R16	Same as R4	
R17	Same as R1	
R18	Potentiometer 25K Multiturn	C1000-154-23
R19	Not used	
R20	Not used	
R21	Not used	
R22	Not used	
R23	Resistor $\frac{1}{2}$ W 10% 220 ohms	
R24	Not used	

PARTS LIST  
MODEL PSA-001,011

ITEM		DRAWING NO.
R25	Not used	
R26	Resistor $\frac{1}{2}$ W 10% 4700 ohms	
R27	Not used	
R28	Resistor 1W 10% 10K	
R29	Not used	
R30	Not used	
R31	Same as R23	
R32	Chosen At Test	
R33	Dual Potentiometer 100K 2 Sections	C1000-154-7
R34	Chosen At Test	
R35	Not used	
R36	Same as R28	
R37	Same as R23	
R38	Same as R23	
R39	Chosen At Test	
R40	Not used	
R41	Part of R33	
R42	Chosen At Test	
R43	Resistor $\frac{1}{2}$ W 10% 330K	
R44	Resistor $\frac{1}{2}$ W 10% 4.7M	
R45	Not used	
R46	Resistor $\frac{1}{2}$ W 10% 270K	
R47	Resistor $\frac{1}{2}$ W 10% 100 ohms	

## PARTS LIST

MODELS PSA-001, 011

ITEM	DESCRIPTION	DRAWING NO.
R48	Potentiometer WW 25K	C1000-154-1
R49	Same as R1	
R50	Same as R26	
R51	Resistor $\frac{1}{2}$ W 10% 8.2K	
R52	Resistor $\frac{1}{2}$ W 10% 2.2K	
R53	Same as R47	
R54	Resistor 2W 10% 27K	
R55	Not used	
R56	Same as R11	
R57	Resistor $\frac{1}{2}$ W 10% 27K	
R58	Resistor $\frac{1}{2}$ W 10% 470K	
R59	Resistor $\frac{1}{2}$ W 10% 1M	
R60	Not used	
R61	Resistor 1W 10% 22K	
R62	Same as R58	
R63	Same as R52	
R64	Resistor $\frac{1}{2}$ W 10% 47K	
R65	Not used	
R66	Potentiometer 25K	C1000-154-14
R67	Resistor $\frac{1}{2}$ W 10% 150 ohms	
R68	Same as R4	
R69	Resistor 1W 10% 47K	
R70	Not used	
R71	Resistor 1W 10% 15K	

## PARTS LIST

MODELS PSA-001, 011

ITEM	DESCRIPTION	DRAWING NO.
R72	Potentiometer Dual 50K	C1000-154-15
R73	Resistor $\frac{1}{2}$ W 10% 330 ohms	
R74	Resistor $\frac{1}{2}$ W 10% 68K	
R75	Not used	
R76	Potentiometer 250K	C1000-154-11
R77	Same as R52	
R78	Same as R4	
R79	Resistor $\frac{1}{2}$ W 5% 10K	
R80	Not used	
R81	Resistor $\frac{1}{2}$ W 10% 220K	
R82	Same as R1	
R83	Resistor $\frac{1}{2}$ W 5% 20K	
R84	Same as R79	
R85	Not used	
R86	Same as R64	
R87	Same as R12	
R88	Resistor $\frac{1}{2}$ W 5% 27K	
R89	Potentiometer 100K	C1000-154-27
R90	Not used	
R91	Resistor $\frac{1}{2}$ W 5% 680K	
R92	Potentiometer WW 10K	
R93	Resistor 1W 10% 10K	
R94	Resistor 1W 10% 33K	
R95	Not used	



PARTS LIST  
MODELS PSA-001, 011

ITEM	DESCRIPTION	DRAWING NO.
R96	Potentiometer Dual 10K (Part of R72)	C1000-154-15
R97	Same as R69	
R98	Same as R6	
R99	Same as R6	
R100	Not used	
R101	Same as R48	
R102	Resistor $\frac{1}{2}$ W 1% 39K	Dale Electronics MFF $\frac{1}{2}$ T1
R103	Same as R48	
R104	Resistor $\frac{1}{2}$ W 1% 47K	Dale Electronics MFF $\frac{1}{2}$ T1
R105	Not used	
R106	Same as R48	

## PARTS LIST

MODELS PSA-001, 011

ITEM	DESCRIPTION	DRAWING NO.
C1	40-20-10-10 @ 300V Electrolytic	Sprague TVL 4578
C2	Capacitor .1 MFD 200V	Sprague TVL 192P10492
C3	Same as C2	
C4	Capacitor 470 MMF	CM15E471J
C5	Same as C4	
C6	Same as C2	
C7	Same as C2	
C8	Not used	
C9	Not used	
C10	Not used	
C11	Capacitor .01 MFD @ 600V	Erie 811Z5V103P
C12	Trimmer 2.5-11 MMF	Erie 538-090
C13	Not used	
C14	Same as C2	
C15	Not used	
C16	Same as C12	
C17	15-15 @ 350V Electrolytic	Sprague TVL 2625
C18	Same as C2	
C19	Not used	
C20	Not used	
C21	Same as C11	
C22	Same as C11	
C23	Not used	
C24	Same as C11	

PARTS LIST  
MODELS PSA-001, 011

ITEM	DESCRIPTION	DRAWING NO.
C25	Not used	
C26	Same as C11	
C27	Same as C4	
C28	Same as C2	
C29	Same as C11	
C30	Not used	
C31	Same as C11	
C32	Same as C2	
C33	Same as C2	
C34	Capacitor .047 @ 200V	Sprague 192P47392
C35	Not used	
C36	Same as C2	
C37	Capacitor Mica 270 MMF	CM15E271J
C38	Same as C34	
C39	Not used	
C40	Not used	
C41	Not used	
C42	Capacitor Disc .001 MFD @ 600V	Erie 811Z5V102P
C43	Same as C11	
C44	Same as C2	
C45	Same as C11	
C46	Same as C34	
C47	Same as C34	
C48	Same as C11	

PARTS LIST

MODELS PSA-001, 011

ITEM	DESCRIPTION	DRAWING NO.
C49	Same as C42	
C50	Not used	
C51	Same as C42	
C52	Not used	
C53	Not used	
C54	Not used	
C55	Not used	
C56	Same as C42	
C61	Capacitor .1 @ 600V	Condenser Products EAW 104 6C
	Video Filter Assy	A1000-166

## PARTS LIST

MODELS PSA-001, 011

ITEM	DESCRIPTION	DRAWING NO.
Y1	Crystal Pair	A1000-007-1
Y2	Paired with Y1	
V1	Tube Electron	5879
V2	Tube Electron	6BH6
V3	Same as V2	
V4	Tube Electron	12AT7
V5	Tube Electron	19EA8
V6	Tube Electron	6201
V7	Same as V4	
V8	Tube Electron	6AU6
V9	Tube Electron	6BY8

## PARTS LIST

MODELS PSA-001, 011

ITEM	DESCRIPTION	DRAWING NO.
	Attenuator, Input	A1000-178
	Attenuator, range	A1000-164
Z1	Transformer I.F.	A1000-009-1
Z2	Same as Z1	
Z3	Same as Z1	
Z4	Transformer Osc	A1000-008-1
Z5	Not used	
Z6	Same as Z1	
Z7	Same as Z1	
CR1	Diode	IN34A
S1	Not used	
S2	Switch Toggle DPDT Min.	Milli-Switch TT-2
S3	Not used	
L1	Choke 22 MHY	Miller Radio Products 70F222A1
L2	Choke 6.8	National Radio 1550-23
L3	Same as L2	
J1	Connector-BNC	UG 625 B/U
J2	Same as J1	
P1	Lead	H.H. Smith 1510-24
P2	Connector	Amphenol 26-159-16

